

01322 621700

**Texcel**  
**Technology**

Electronic  
Manufacturing  
Solutions

UK Based. UK Manufacture.  
Selling throughout the World.

A Guide To  
**DESIGN FOR MANUFACTURE**  
**DFM**  
By Michael Keens

[www.texceltechnology.com](http://www.texceltechnology.com) Enquiries: 01322 621 700

follow us



## Table of Contents

<b>Introduction</b>	<b>3</b>
<b>Considerations</b>	<b>3</b>
<b>The key considerations of Design for Manufacturability are as follows:-</b>	<b>3</b>
<b>Component selection</b>	<b>3</b>
<b>PCB tracking design</b>	<b>3</b>
<b>Via hole positioning</b>	<b>3</b>
<b>PCB panel design</b>	<b>3</b>
<b>Surface mount component positioning</b>	<b>3</b>
<b>Incorrect pad size or design for part geometry</b>	<b>3</b>
<b>Conventional component positioning</b>	<b>3</b>
<b>Suitability for test</b>	<b>3</b>
<b>Component selection</b>	<b>3</b>
<b>PCB tracking design</b>	<b>5</b>
<b>Via hole positioning</b>	<b>6</b>
<b>PCB panel design</b>	<b>8</b>
<b>Surface mount component positioning</b>	<b>9</b>
<b>Incorrect pad size or design for part geometry</b>	<b>9</b>
<b>Conventional component positioning</b>	<b>10</b>
<b>Suitability for test</b>	<b>11</b>
<b>Conclusion</b>	<b>12</b>

## Introduction

The purpose of engineering a PCB assembly for manufacture is to improve the product design in three ways: quality, cost and delivery (QCD). Utilizing sound Design For Manufacture (DFM) practices will ensure high quality products, provide cost reductions, and shorten delivery lead times. In this day of global competition where quality, cost and speed to market are the key to a successful product, too often very simple mistakes are found late in the production process that could have been easily avoided during the design stage. With respect to the cost of a product, the majority is committed during the product design stage and so the earlier the DFM involvement the lower the cost to implement.

## Considerations

The key considerations of Design for Manufacturability are as follows:-

- Component selection
- PCB tracking design
- Via hole positioning
- PCB panel design
- Surface mount component positioning
- Incorrect pad size or design for part geometry
- Conventional component positioning
- Suitability for test

## Component selection

For medium to high volume PCB assembly the more of the production process that can be automated the better and so surface mount technology is preferred over conventional or through-hole technology due to it's suitability to be easily placed by automatic machine. The image below shows a typical surface mount component along side a conventional component.

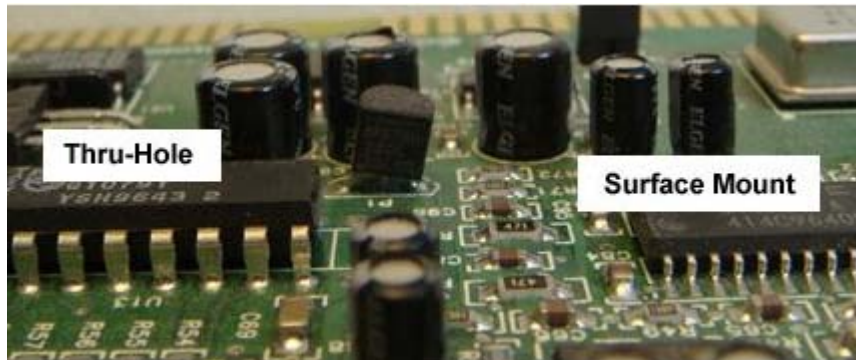

Example image showing both through-hole and surface mount technologies.

There is an increasing variety of surface mount components available on the market, with a trend of ever decreasing size. This is mainly being driven by the need to fit more components and functionality into smaller spaces – below are two images which show various surface mount components giving an idea of scale (the image on the right is of components placed on the head of a matchstick). It is important to be aware that not all components are straight forward to handle and some require specialized equipment to place.

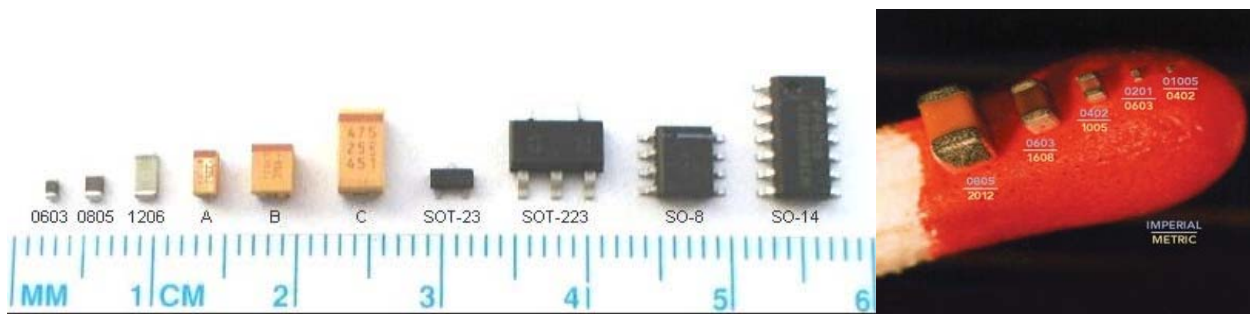

As PCB designs have gained complexity the demand for the number of connections to a device has increased as well as the demand for board space. Below are images showing how integrated circuits have evolved to first increase the number of connections to a device and then to increase the amount of functionality in a given space.

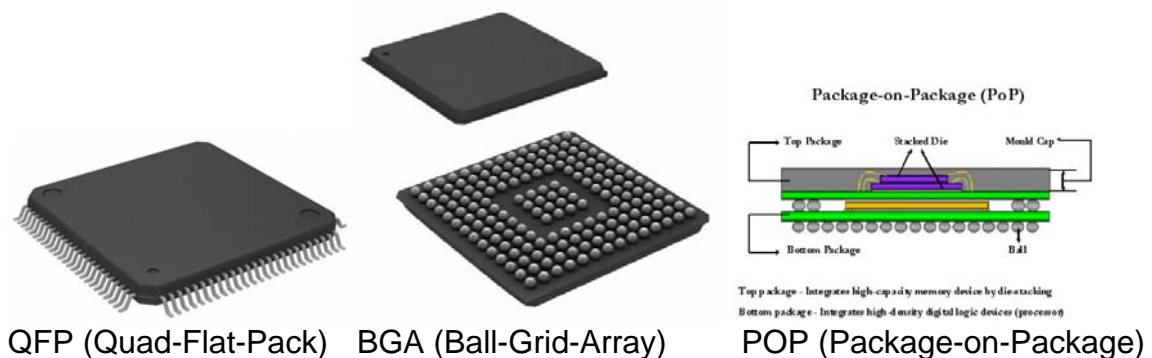

It is even more important for these type of devices to be aware that not all components are straight forward to handle and some require specialized equipment to place and inspect.

Another important aspect of component selection is to keep the number of different parts to a minimum. The reason being that the fewer different components on a design generally the lower the cost will be because of the reduced machine setup time. There will also be a reduction in the chance of error and less parts to procure. It would also be prudent at this stage to check for part obsolescence before specifying components to be used.

If conventional components are specified, then “pin-in-paste” or “intrusive reflow” should be considered. The diagram below shows the process of printing over the holes in the PCB, placing the component and then reflow soldering with the other surface mount parts to form the solder joints. It is very important for this process that compatible parts are selected that do not smudge the solder paste when placed and that can also withstand the reflow soldering temperatures.

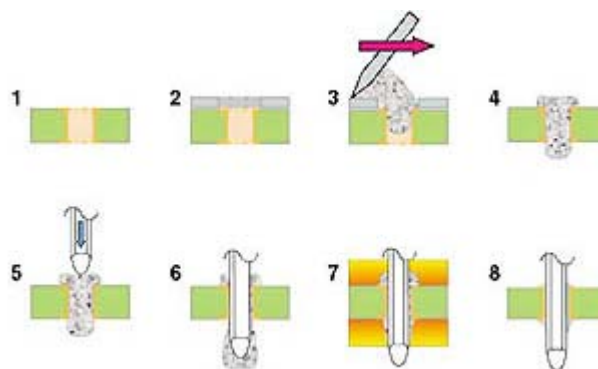

### PCB tracking design

With respect to the tracking layout within a PCB design there are aspects that should be considered specifically for manufacturability:-

**Tombstoning:-** If the tracks leading to a component footprint are not thermally balanced then during the reflow soldering process one side of the component footprint will heat quicker than the other causing the solder to melt on one side first instead of at the same time. Below are some illustrations:-



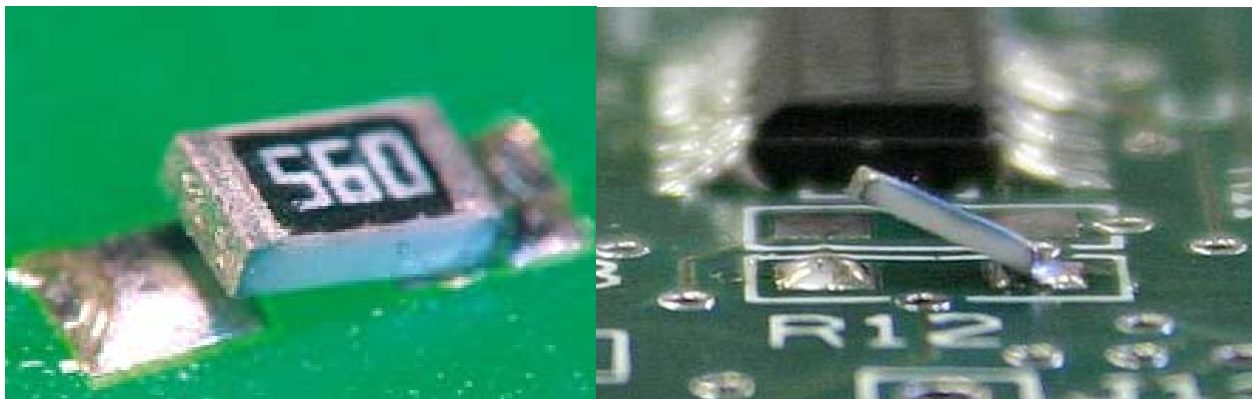
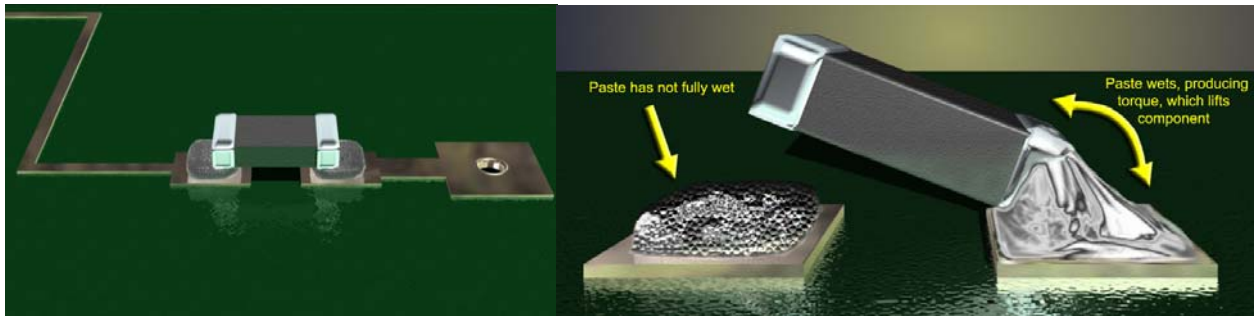

This can be avoided by balancing the tracks widths where possible to ensure that pads heat at the same rate. If one side is connected to a ground plane then thermal relief should be applied examples of which can be seen below:-



Basic Thermal --- Rotated Thermal --- Square Thermal

Copper pull-back:- All copper layers especially ground layers should not extend to the edge of the PCB design and should be pulled back from the edge to allow for 'V grooving' when panelising. The result of not pulling the copper back from the edge and if the PCB is panelized using 'V grooving' then it is possible for short circuits to occur between layers.

### Via hole positioning

Via holes positioned in pad areas should be avoided. This can have a big impact on component solder joints during the reflow process, if the via is not isolated by solder resist,

it can cause solder to wick down the hole and give a resulting dry joint – see below for two examples.

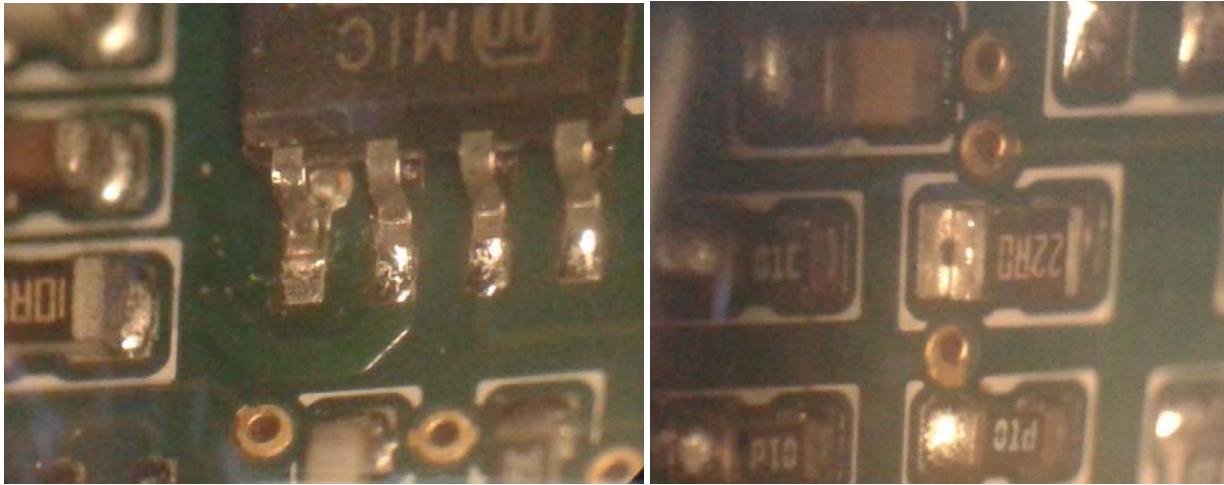

To avoid this situation vias should be positioned away from solder joints and kept separate using solder resist. There are occasions when vias are required to be incorporated within pads for thermal purposes and in these cases solder resist can be used to keep the solder from going down the holes. See below for example footprints with and without solder resist

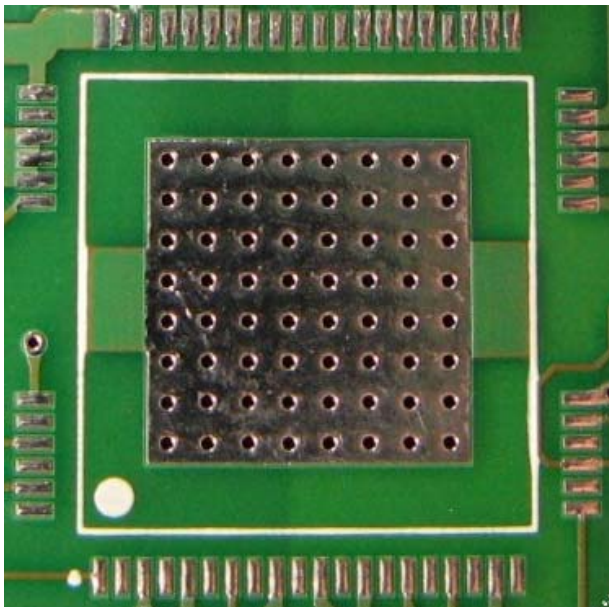

Component footprint with vias to help

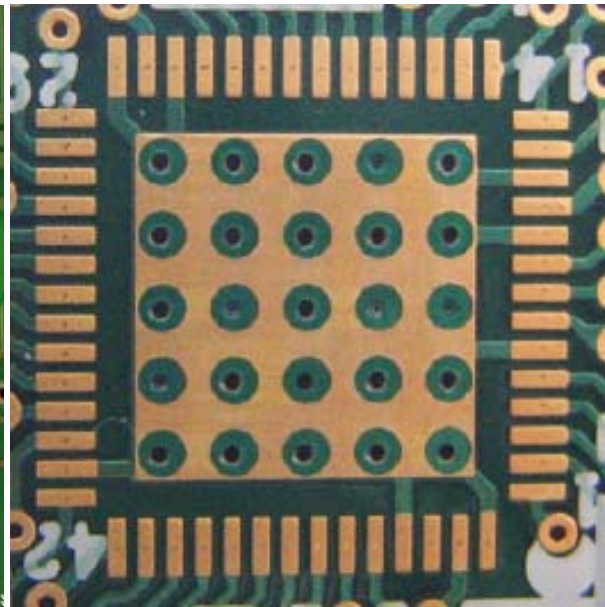

Vias including solder mask to stop flow of solder into holes

## PCB panel design

To allow for an efficient manufacturing process PCB designs are generally designed within a rectangular panel or frame to ensure they can be processed through the many machines that make up the surface mount assembly process – i.e. printing, placement, reflow. Depending on the size of the PCB design it may be kept to single circuit or it maybe step and repeated so multiple PCB's can be built maximizing machine time. This has the advantage of utilizing the bare PCB material in the most efficient and cost effective way, however it also means that PCB's should only be ordered in multiples of the panel quantity.

An effective PCB panel design would incorporate the following:-

- allow for any shape PCB design to be processed
- include a minimum of two handling edges (top and bottom) to allow for components near to the edges not to be disturbed by machine PCB holding mechanism
- have an acceptable method of removing PCB from the panel – either v-grooving or routing. When routing, 'rat-bite' breakouts are typically used.
- include a method of optically aligning PCB – Typically 3 fiducial marks
- have multiple copies of the design where appropriate

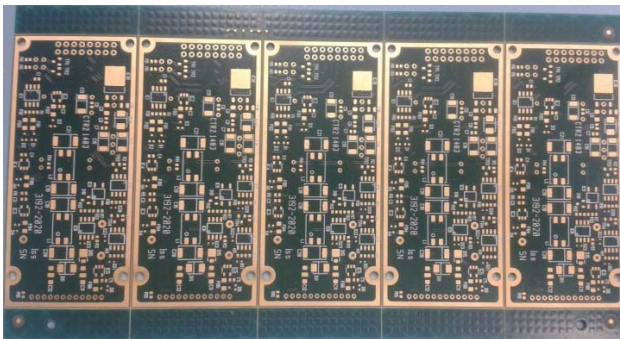

Example v-groove panel design

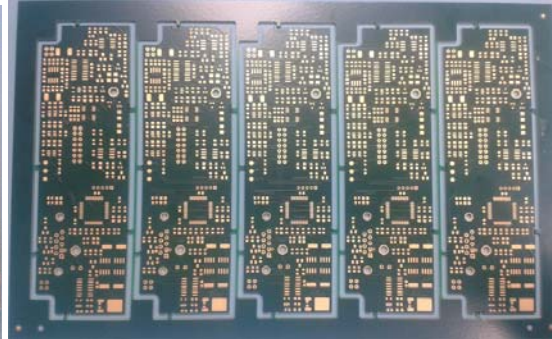

Example routed panel design

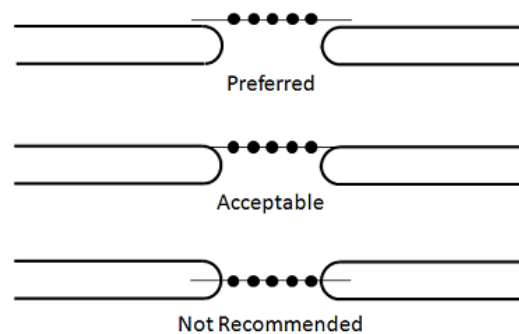
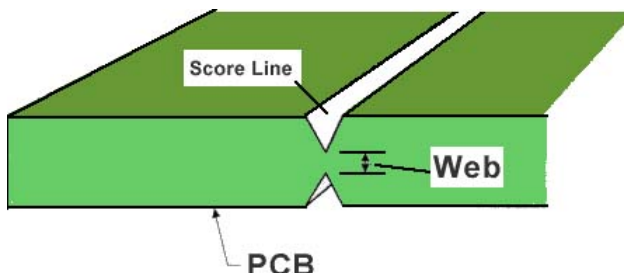



## Surface mount component positioning

When positioning surface mount components it is important to have an understanding of the manufacturing process in order to keep the manufacturing cost to a minimum and reduce the chance of error. Most PCB design packages will contain design rules that govern component positioning and IPC also have developed a standard (IPC\_7531) that can be a useful guide.

Automatic optical inspection (AOI) should also be considered to ensure as many parts as possible can be automatically inspected. All parts including their footprints should be completely visible from above so that solder joints can be inspected as well as the component body. Below is an example of a placement error that may not be possible to detect using AOI:-



If the number of components is such that parts need to be mounted on both sides of the PCB then thought needs to be made to ideally position all heavy components (where total pad area to weight ratio is less than 30g per square inch) on one side of the board.

## Incorrect pad size or design for part geometry

Each component to be fitted to a PCB needs to have a footprint designed that allows for a visible solder fillet to form. IPC\_7531 can be referred to for general guidance and there is also a more detailed standard which is IPC\_782.

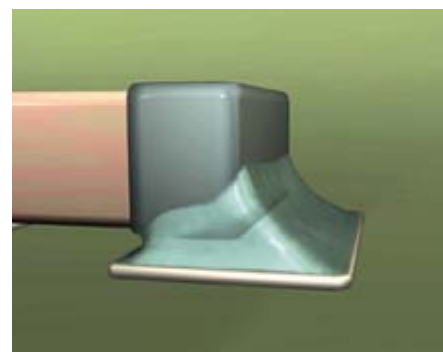
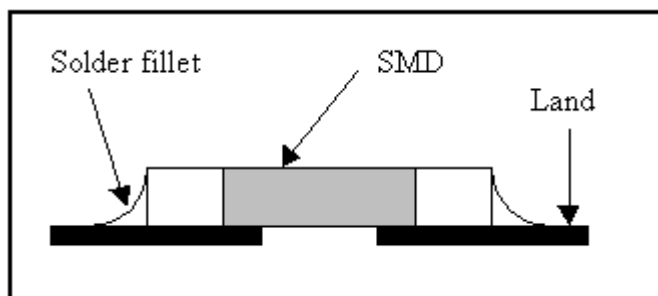

Acceptable pad design providing visible uniform solder fillet

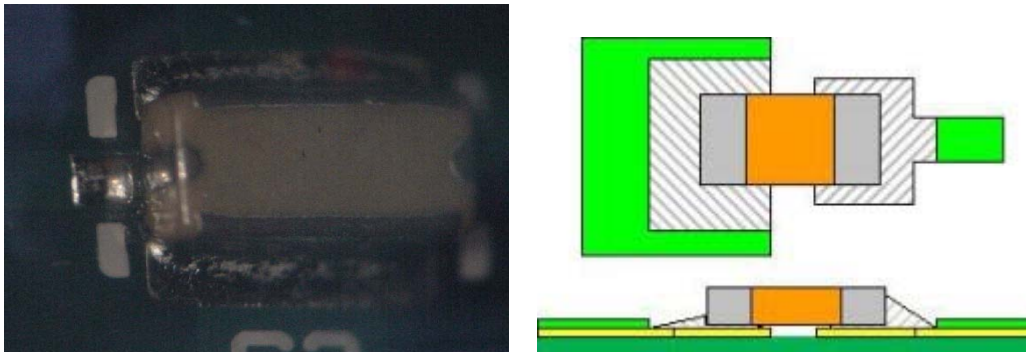

### Conventional component positioning

The positions of conventional or through-hole components can have a big impact on the chance of error and manufacturability of an assembly. Where possible it is recommended to position parts in a way such that an error is not possible or as unlikely as possible – Poka Yoke.

The advantages of Poka Yoke systems are as follows:-

- Minimizes or avoid risk of error
- The operator can focus on the operations that add value
- Generally easy and cheap to implement

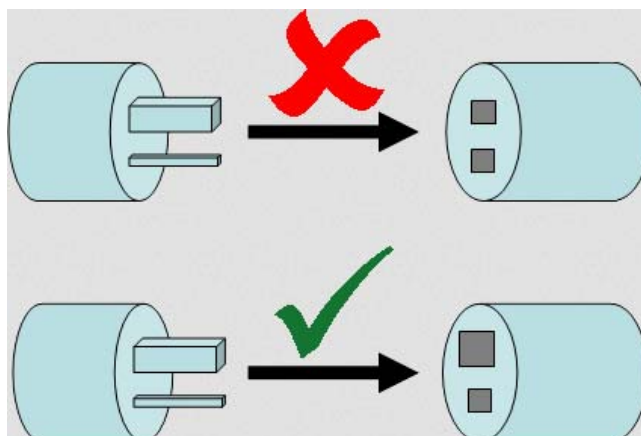

The position of conventional components in relation to surface mount is important to facilitate automation processes such as 'wave solder'. It is important to allow enough

clearance between parts to allow for tooling to be used such as wave solder pallet. The example image below shows how the solder pallet forms a seal to protect the surface mount parts fitted to the underside of the PCB. Distance 'X' should be no smaller than 3mm.

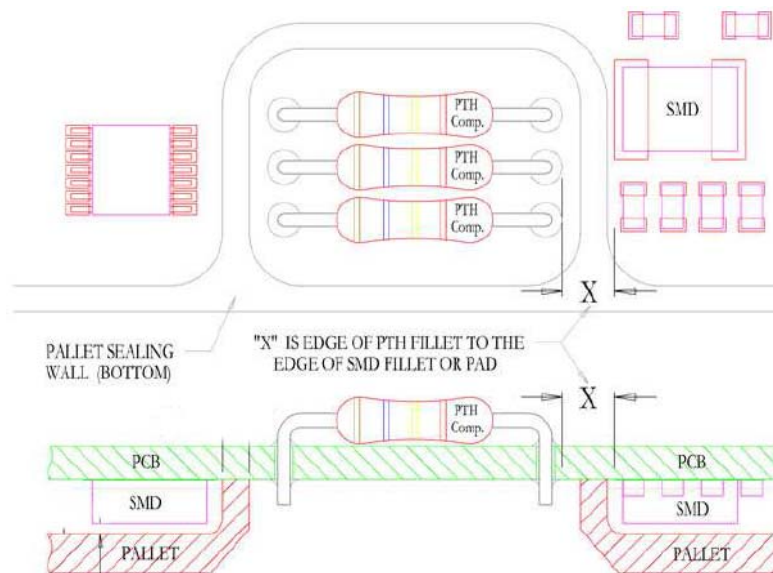

### Suitability for test

Testability is important part of PCB design to ensure that ideally every part placed can be tested and verified to be correct. Certain components because of their geometry cannot be probed directly and so it is possible to either modify the footprint or to include test points within the track as can be seen below. Component testability should be considered whether the assembly is intended to be tested using a 'bed of nails' or flying probe tester. Boundary scan and functional testing may also be required near the final stage of release and so it is important that considerable attention is given to how this will be achieved to meet the required level of quality.

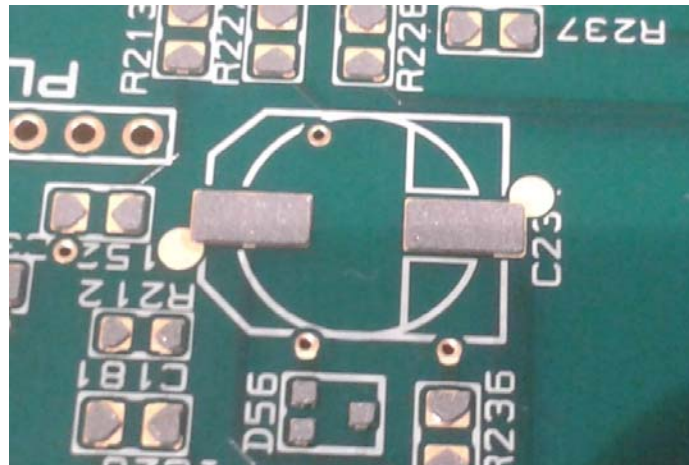

Test Probe Points Added

## Conclusion

The ultimate purpose of design for manufacture is customer satisfaction and is achieved by manufacturing with the most repeatable desired results, by standardizing the processes at the smallest cost in the shortest time.

It is important to note that this document doesn't cover all aspects of PCB design for manufacture but does act as a guide to raise awareness of some of the important considerations that should be made during the design phase.

Texcel Technology Plc have a team of design and New Product Introduction (NPI) engineers who are able to work with designers to help solve these problems and establish strategies to deliver the expected results.



01322 621700

**Texcel**  
**Technology**

Electronic  
Manufacturing  
Solutions

[www.texceltechnology.com](http://www.texceltechnology.com) Enquiries: 01322 621 700

follow us  
  